

L'acier dans l'immeuble One on One

10 novembre 2015

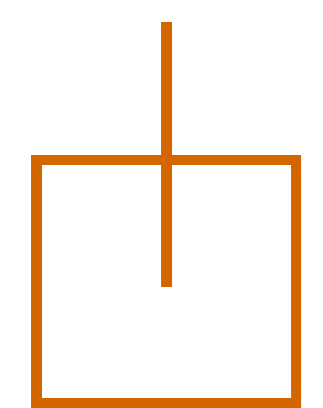

Une présentation en 3 axes

1. La stratégie du propriétaire

Philippe Grisard
Ikogest (M.O.D.) et représentant du M.O.

2. Les choix architecturaux

Stefano Moreno
Moreno Architecture & Associés

3. Les moyens techniques

Walter de Toffol
INCA Ingénieurs Conseils Associés

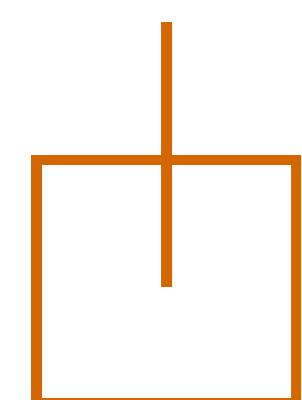

1. La stratégie du propriétaire

- Ikogest, **développeur immobilier** et gestionnaire de fonds immobiliers, depuis **1989** au Luxembourg
- **Philippe Grisard**, ingénieur en construction, 25 bâtiments construits au Luxembourg. Quelques références :



Laccolith
Cloche d'Or
13.300 m², 2002



Atrium Business Park
Bertrange
50.000 m², 2006/2011



Cubus à Howald
15.000 m²
2009/2010



10 Charlotte
Luxembourg-Ville
5.000 m², 2013



1 boulevard Royal
Luxembourg-Ville
2.500 m², 1998/2013

- Terrain 1 route d'Esch, depuis 2005 propriété d'un fonds géré par Ikogest, qui garde en portefeuille des actifs **long-terme**
- Volonté de **créer une adresse** de prestige, un **highlight** architectural à Luxembourg-Ville

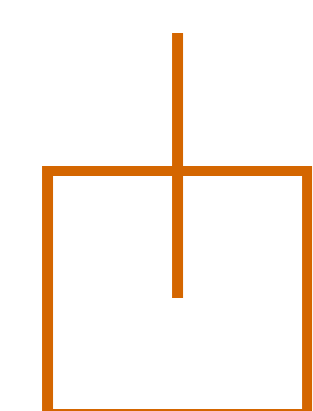

1. La stratégie du propriétaire

- Début de la construction en février 2014, livraison début 2016
- Optimisation de la valeur de l'immeuble qui va rester en portefeuille, volonté de qualité pérenne :
 - Joyau architectural
 - Optimisation des surfaces locatives, 3.000 m² de bureaux
 - Pré-certification Breeam Excellent, meilleur score du Luxembourg pour un bâtiment neuf
- Commercialisation : nombreux contacts, en cours de négociation. Nous prenons le temps de choisir un locataire de référence pour bail long-terme.

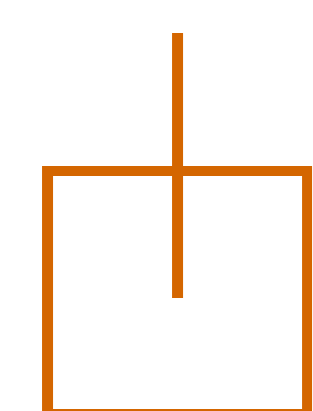

2. Les choix architecturaux

Sous-sol -1

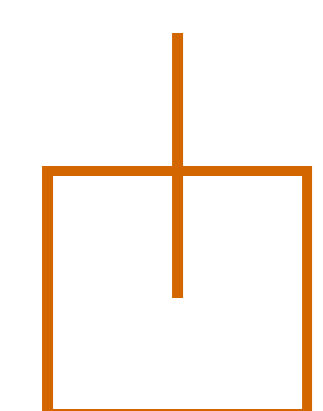

2. Les choix architecturaux

Niveau +1

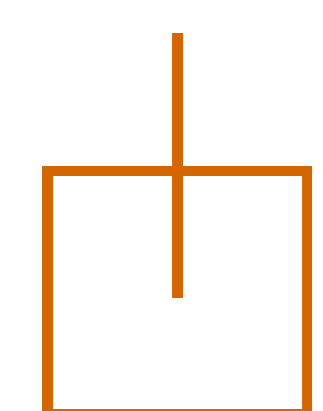
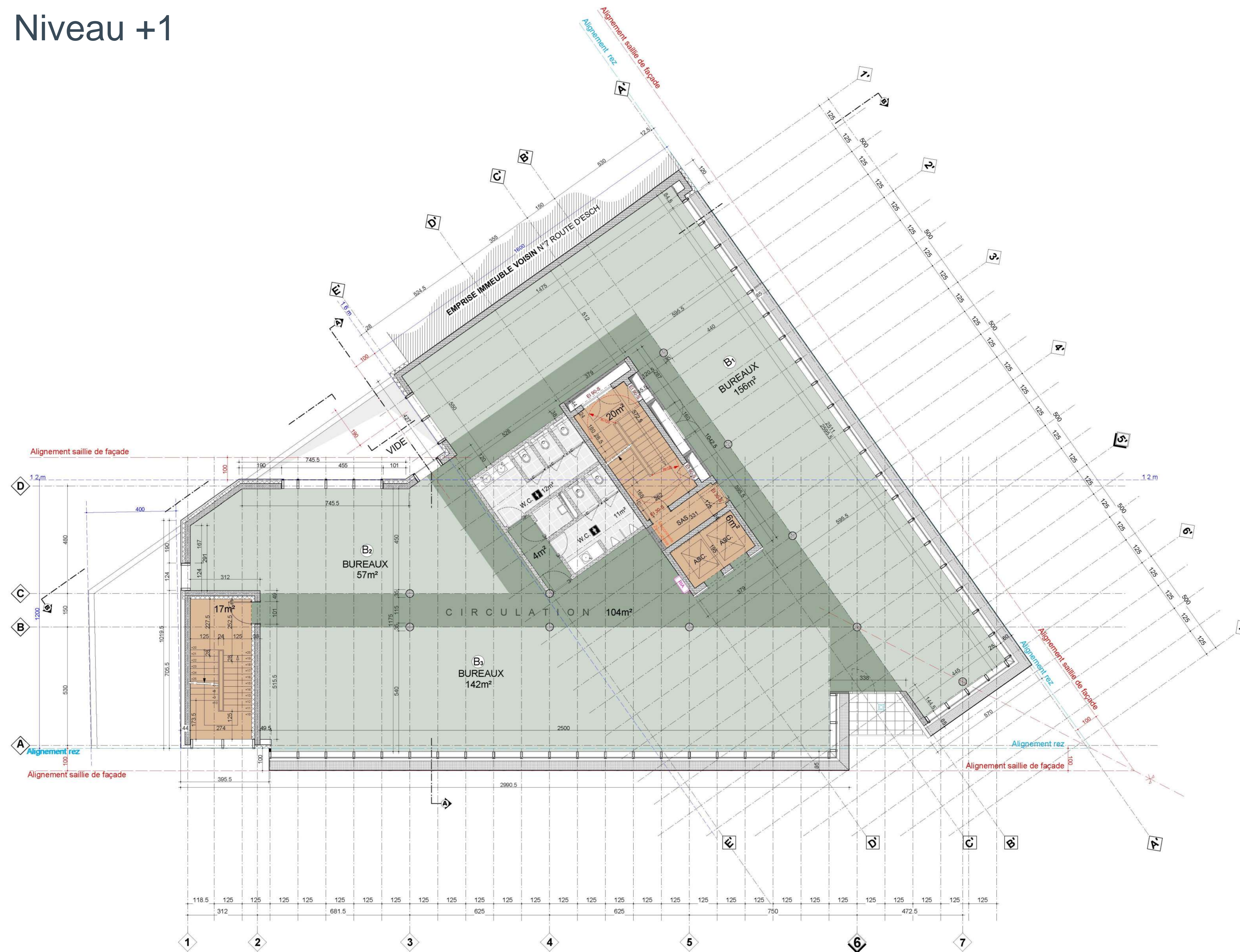

2. Les choix architecturaux

Niveau +2

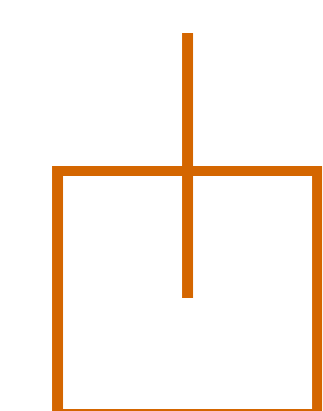

2. Les choix architecturaux

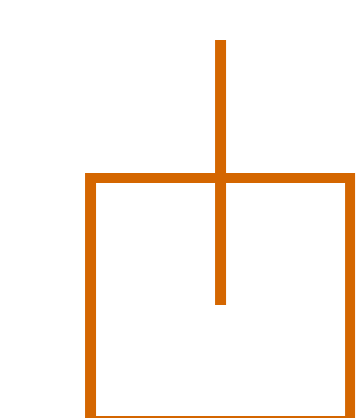
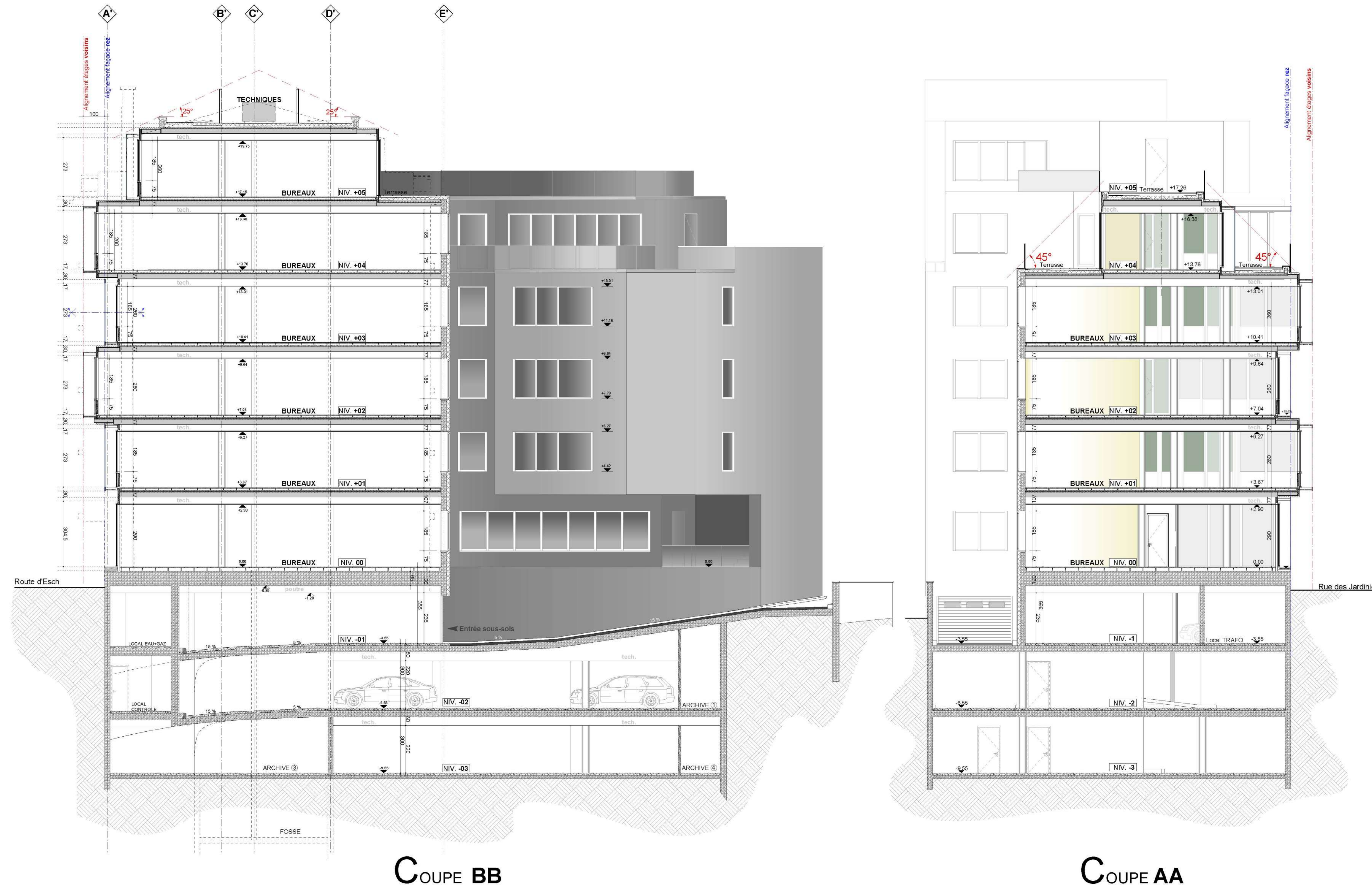

2. Les choix architecturaux

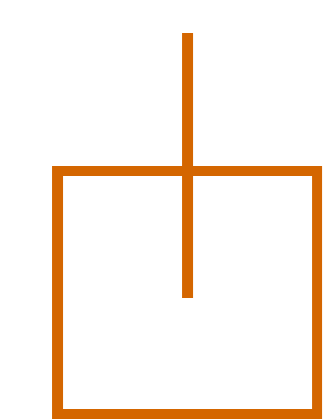
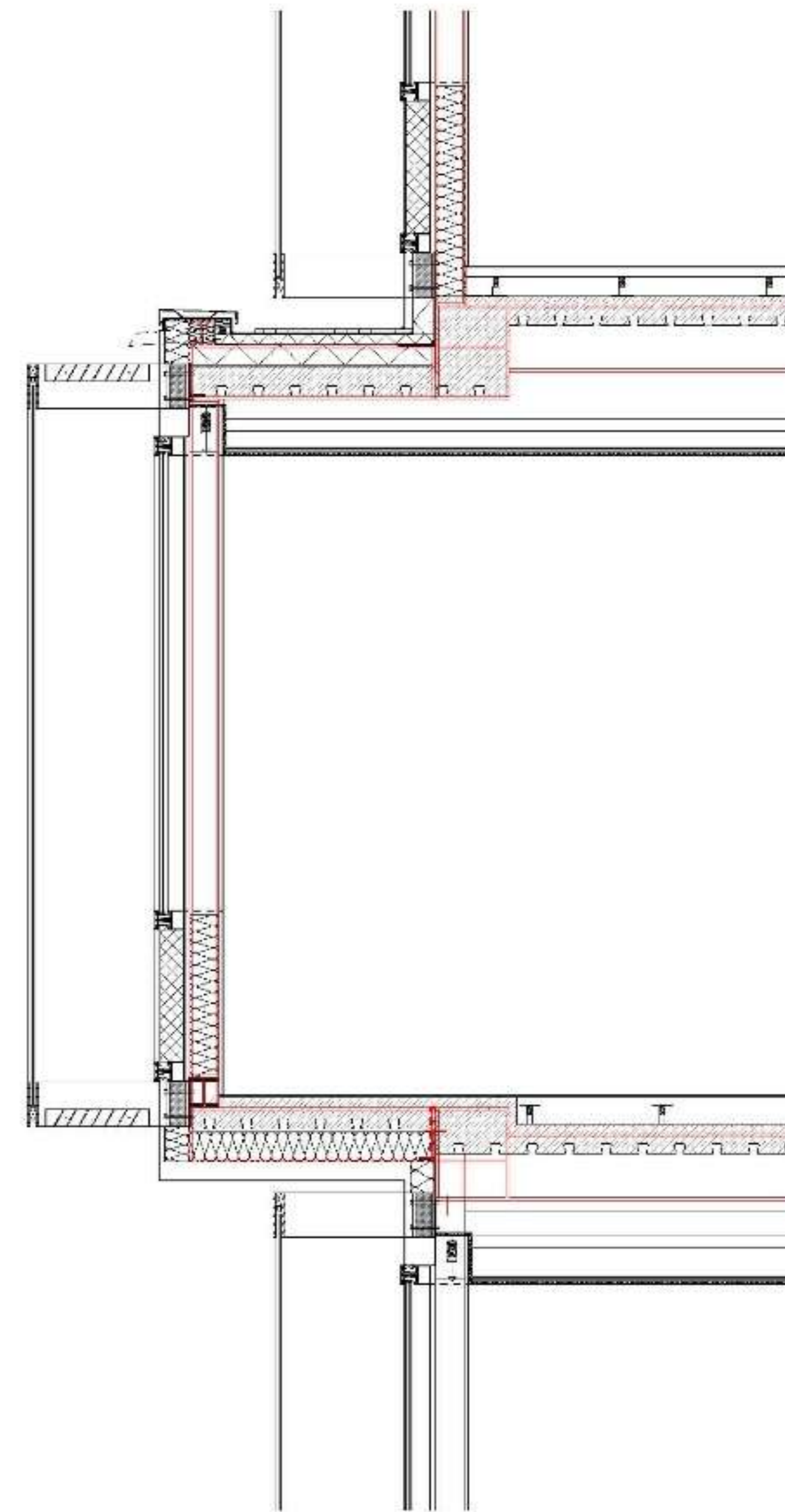

2. Les choix architecturaux

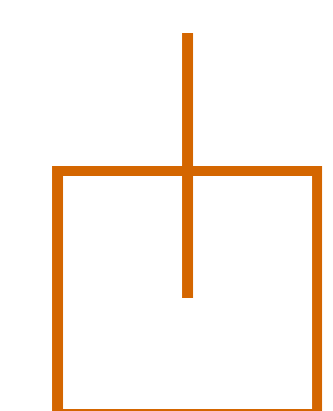
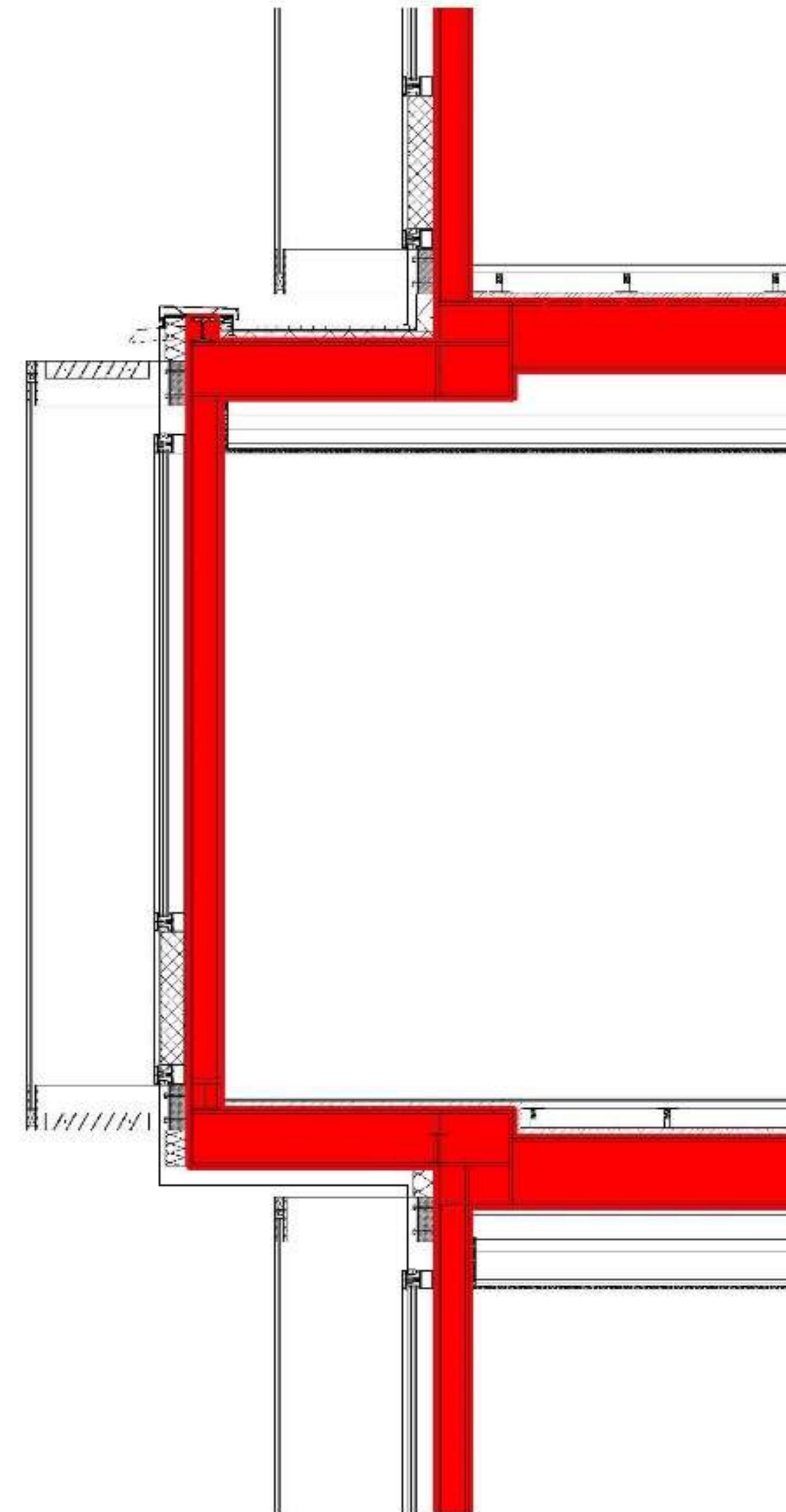

2. Les choix architecturaux

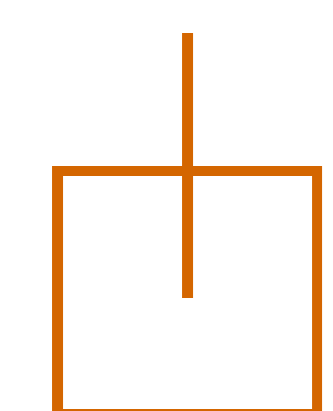
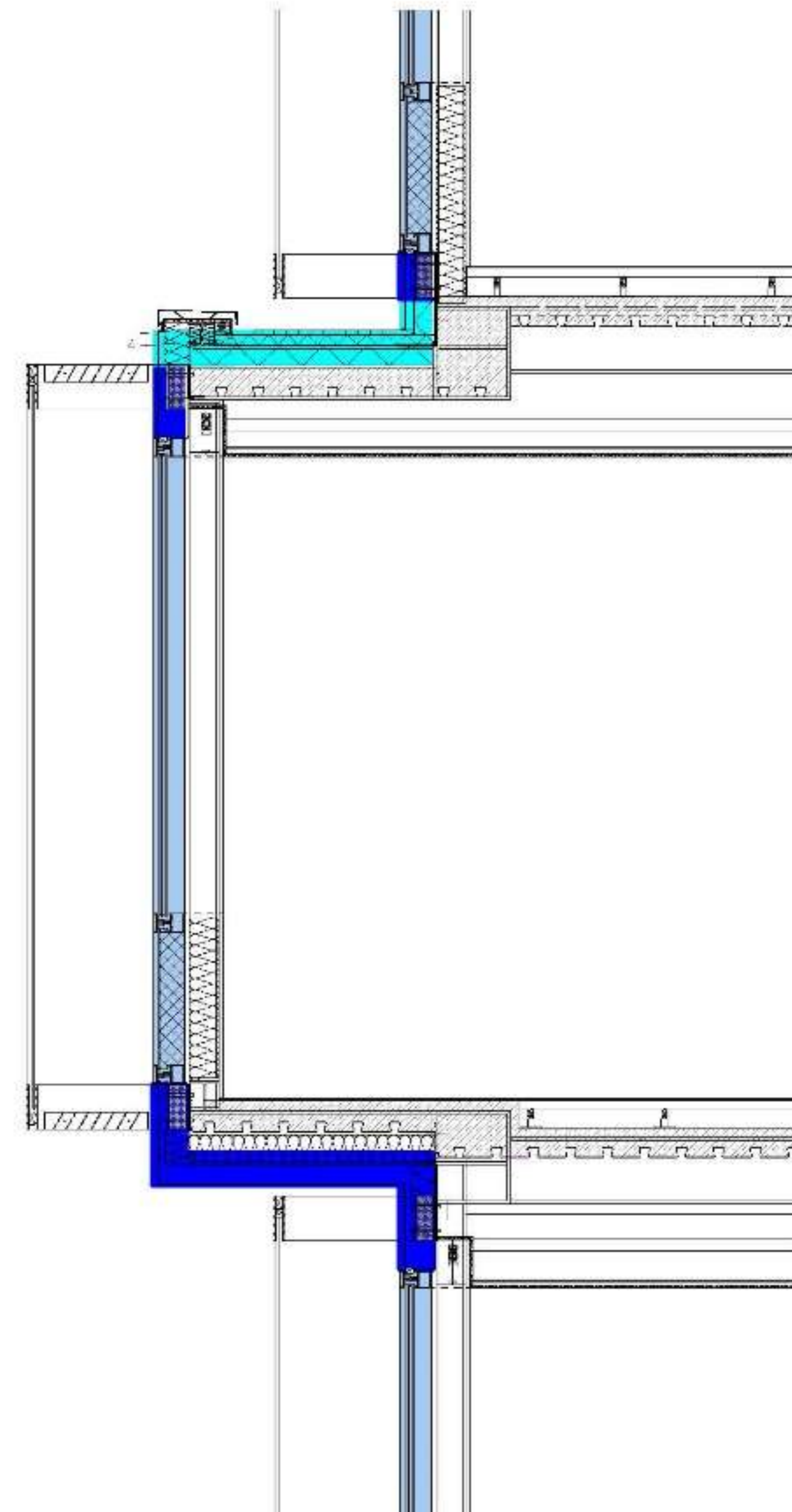

2. Les choix architecturaux

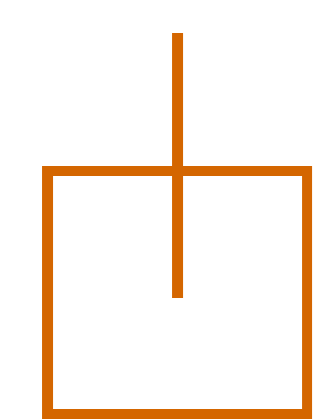
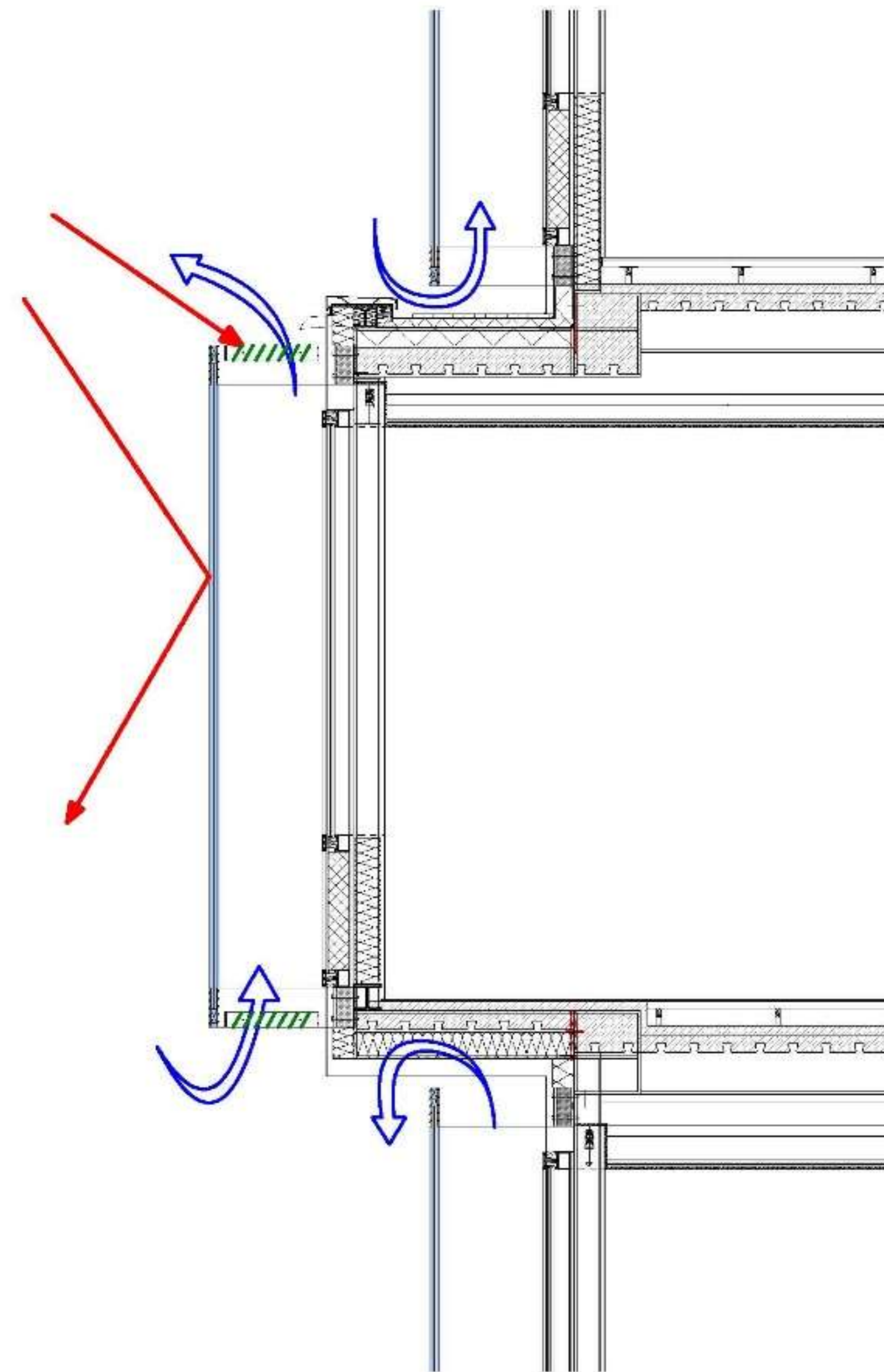

2. Les choix architecturaux

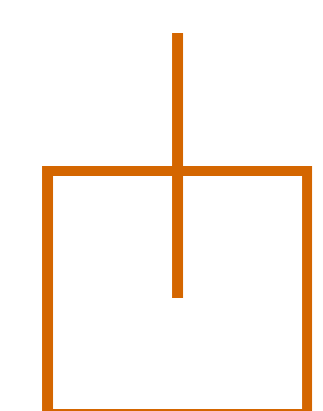
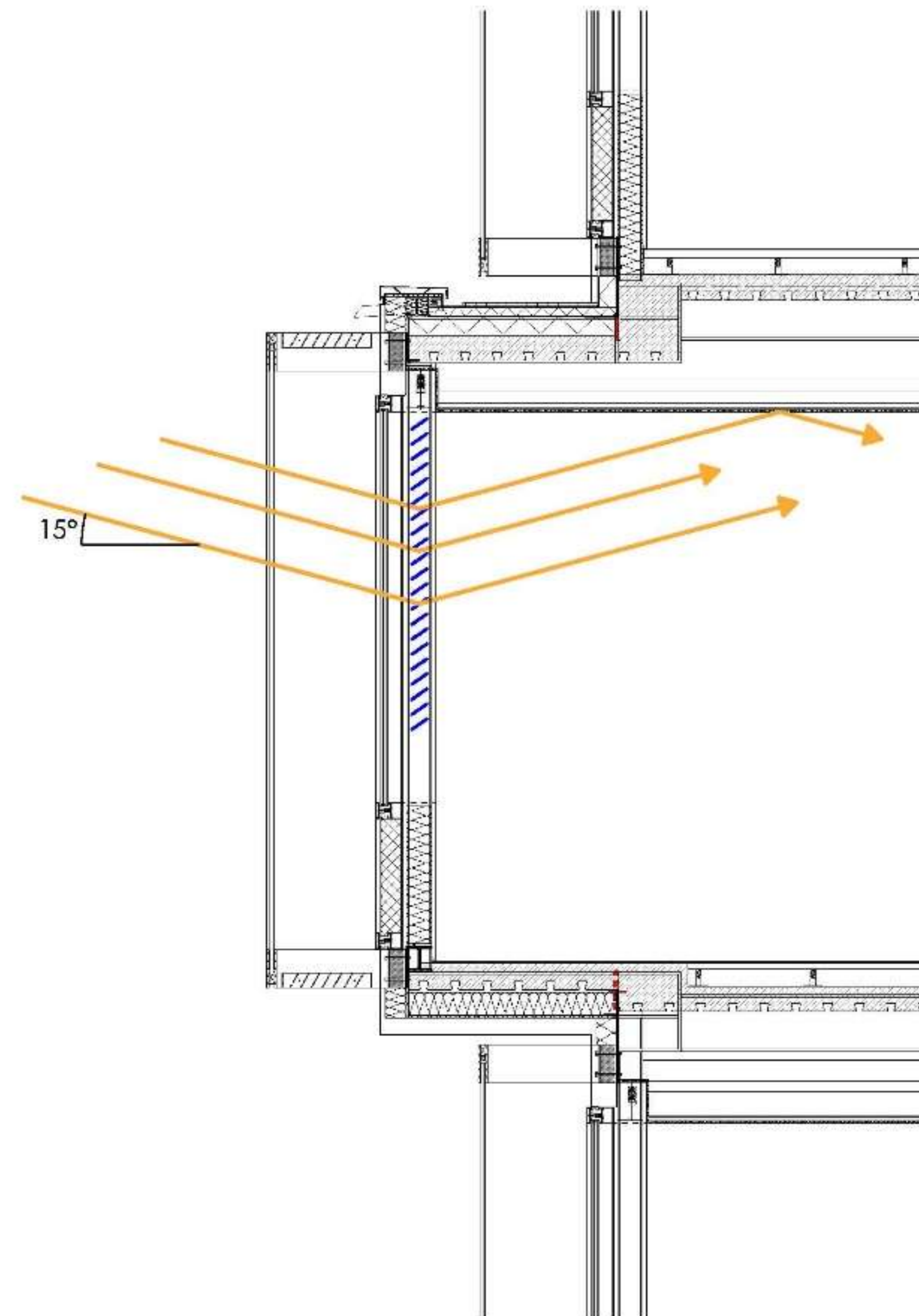

2. Les choix architecturaux

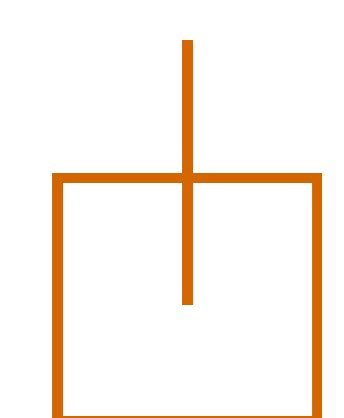

2. Les choix architecturaux

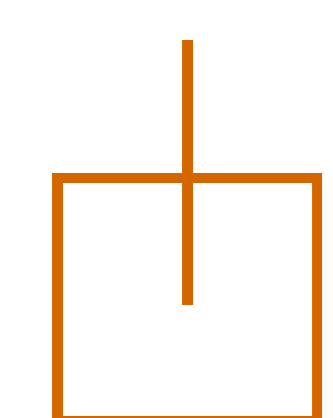

2. Les choix architecturaux

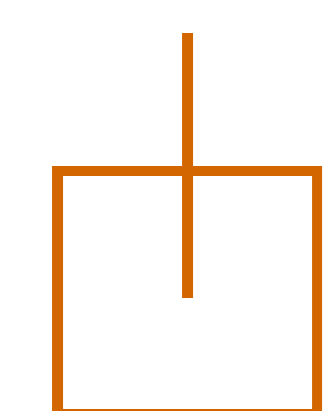

2. Les choix architecturaux

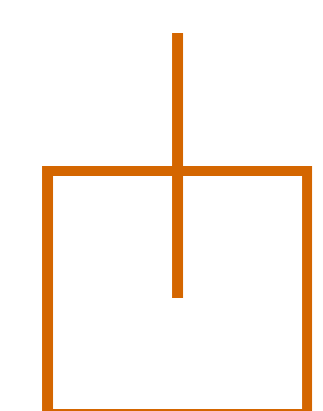

2. Les choix architecturaux

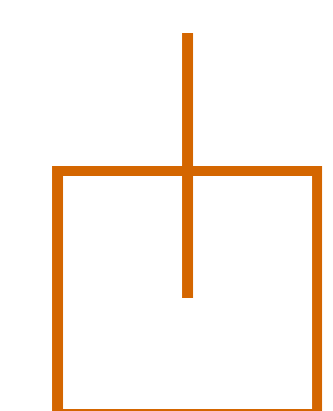
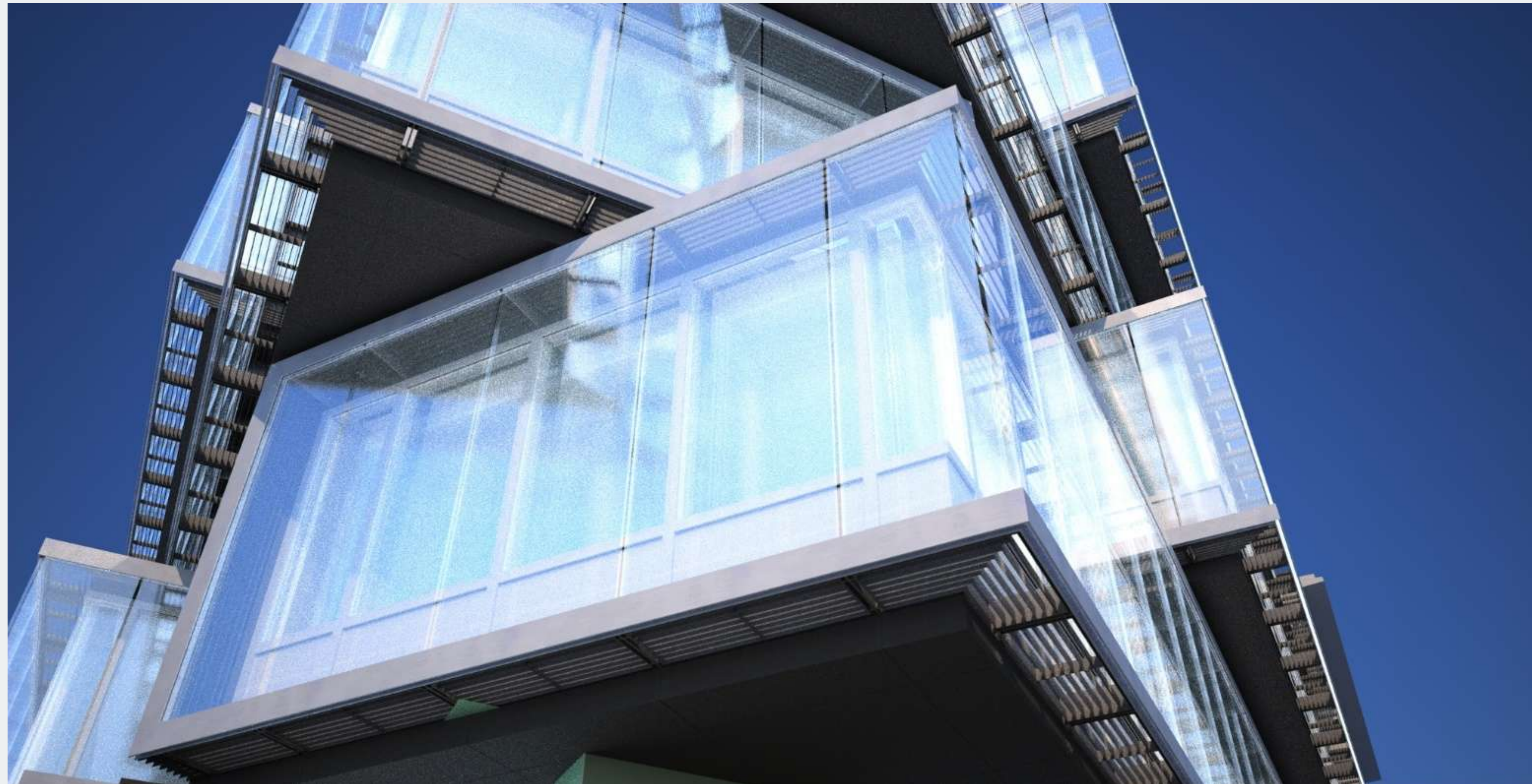

2. Les choix architecturaux

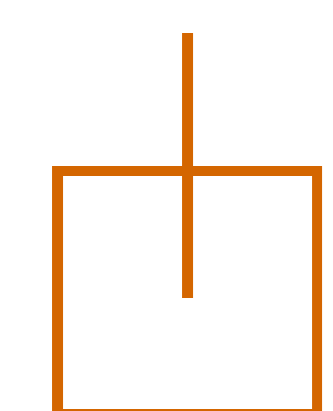

2. Les choix architecturaux

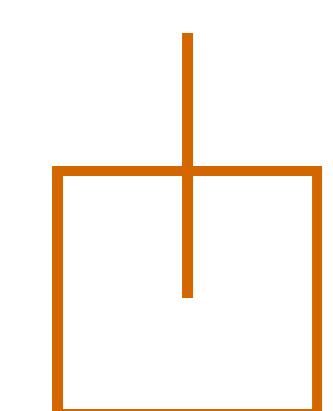

Merci de votre attention

Des questions ?

mail@ikogest.lu
moreno@moreno.lu
info@inca-ing.lu
www.1on1.lu

